

TCH 2010 E / TCH 2011 E

EN

OPERATING MANUAL
DESIGNER GLASS CONVECTOR



EN This product is only suitable for well insulated spaces or occasional use.

 TROTEC

Table of contents

Notes regarding the operating manual..... 2

Safety 2

Information about the device..... 5

Transport and storage..... 6

Assembly and installation..... 6

Operation 7

Errors and faults..... 10

Maintenance 11

Technical annex..... 11

Disposal 13

Notes regarding the operating manual

Symbols

 **Warning of electrical voltage**
 This symbol indicates dangers to the life and health of persons due to electrical voltage.

 **Warning of hot surface**
 This symbol indicates dangers to the life and health of persons due to hot surface.

 **Warning**
 This signal word indicates a hazard with an average risk level which, if not avoided, can result in serious injury or death.

 **Caution**
 This signal word indicates a hazard with a low risk level which, if not avoided, can result in minor or moderate injury.

Note
 This signal word indicates important information (e.g. material damage), but does not indicate hazards.

 **Info**
 Information marked with this symbol helps you to carry out your tasks quickly and safely.

 **Follow the manual**
 Information marked with this symbol indicates that the operating manual must be observed.

You can download the current version of the operating manual and the EU declaration of conformity via the following link:

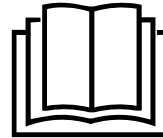

TCH 2010 E



<https://hub.trotec.com/?id=41233>

TCH 2011 E



<https://hub.trotec.com/?id=41234>

Safety

Read this manual carefully before starting or using the device. Always store the manual in the immediate vicinity of the device or its site of use!

 **Warning**
Read all safety warnings and all instructions. Failure to follow the warnings and instructions may result in electric shock, fire and / or serious injury. **Save all warnings and instructions for future reference.**

This appliance can be used by children aged from 8 years and above and persons with reduced physical, sensory or mental capabilities or lack of experience and knowledge if they have been given supervision or instruction concerning use of the appliance in a safe way and understand the hazards involved. Children shall not play with the appliance. Cleaning and user maintenance shall not be made by children without supervision.

 **Warning**
 Children of less than 3 years should be kept away unless continuously supervised. Children aged from 3 years and less than 8 years shall only switch on/off the appliance provided that it has been placed or installed in its intended normal operating position and they have been given supervision or instruction concerning use of the appliance in a safe way and understand the hazards involved. Children aged from 3 years and less than 8 years shall not plug in, regulate and clean the appliance or perform user maintenance.



Warning

Do not use the device in small rooms if persons are present who cannot leave the room independently and who are not under constant supervision.

- Do not use the device in potentially explosive rooms.
- Do not use the device in aggressive atmosphere.
- Set the device up in an upright and stable position.
- Let the device dry out after a wet clean. Do not operate it when wet.
- Do not use the device with wet or damp hands.
- Do not expose the device to directly squirting water.
- Never insert any objects or limbs into the device.
- Do not cover or transport the device during operation.
- Do not remove any safety signs, stickers or labels from the device. Keep all safety signs, stickers and labels in legible condition.
- Do not sit on the device.
- This appliance is not a toy! Keep away from children and animals. Do not leave the device unattended during operation.
- Check accessories and connection parts for possible damage prior to every use of the device. Do not use any defective devices or device parts.
- Ensure that all electric cables outside of the device are protected from damage (e.g. caused by animals). Never use the device if electric cables or the power connection are damaged!
- The electrical connection must correspond to the specifications in chapter Technical data.
- Insert the mains plug into a properly secured mains socket.
- Observe the device's power input, cable length and intended use when selecting extensions to the power cable. Completely unroll extension cables. Avoid electrical overload.
- Before carrying out maintenance, care or repair work on the device, remove the mains plug from the mains socket. Hold onto the mains plug while doing so.
- Switch the device off and disconnect the power cable from the mains socket when the device is not in use.
- Do not under any circumstances use the device if you detect damages on the mains plug or power cable. If the supply cord is damaged, it must be replaced by the manufacturer, its service agent or similarly qualified persons in order to avoid a hazard. Defective power cables pose a serious health risk!

- During the installation of the device observe the minimum distances from walls and other objects as well as the storage and operating conditions specified in the Technical data chapter.
- Do not use the device in immediate proximity to curtains.
- Make sure that the air inlet and outlet are not obstructed.
- Make sure that the suction side is kept free of dirt and loose objects.
- Do not place the device on combustible ground.
- Allow the device to cool down before transport and / or maintenance work.
- Do not use this device near bathtubs, shower trays, swimming pools or other water containers. Risk of electric shock!

Intended use

This product is only designed for use inside well insulated rooms or for occasional use.

Only use the device for heating closed rooms whilst adhering to the technical data.

Intended use comprises heating the air in:

- living spaces
- storerooms
- salesrooms
- construction areas
- containers
- basements

Improper use

- Do not place the device on wet or flooded ground.
- Do not place any objects, e.g. clothing, on the device.
- Do not use this device in the vicinity of fuel, solvents, varnishes or other easily inflammable vapours or in rooms where these substances are stored.
- Do not use the device outdoors.
- Do not use the device for heating vehicles.
- The device must not be used near swimming pools.
- Do not use this device in the immediate vicinity of sinks, bathtubs or other water containers. Never immerse the device in water.
- Any operation other than as described in this manual is prohibited. Non-observance renders all claims for liability and guarantee null and void.
- Any unauthorised modifications, such as alterations or structural changes to the device, are forbidden.

Personnel qualifications

People who use this device must:

- be aware of the dangers that occur when working with electric devices in damp areas.
- have read and understood the operating manual, especially the Safety chapter.

Maintenance tasks which require the housing to be opened must only be carried out by specialist electrical companies or by Trotec.

Symbols on the device

Symbols	Meaning
	This symbol located on the device indicates that it is prohibited to place objects (such as towels, clothes etc.) above or directly in front of the device. In order to avoid overheating and fire hazards, the heater must not be covered.

Residual risks



Warning of electrical voltage

Work on the electrical components must only be carried out by an authorised specialist company!



Warning of electrical voltage

Before any work on the device, remove the mains plug from the mains socket!
Hold onto the mains plug while pulling the power cable out of the mains socket.



Warning of hot surface

Some parts of this product can become very hot and cause burns. Particular attention has to be given where children and vulnerable people are present!



Warning

Improper handling entails a risk of burning and electric shock.
Only use the device as intended!



Warning

Dangers can occur at the device when it is used by untrained people in an unprofessional or improper way!
Observe the personnel qualifications!



Warning

The device is not a toy and does not belong in the hands of children.



Warning

Risk of suffocation!
Do not leave the packaging lying around. Children may use it as a dangerous toy.



Warning

Improper installation entails a risk of fire.
Do not place the device on combustible ground.
Do not place the device on high-pile carpets.
Do not use the device without the feet attached.



Warning

In order to avoid overheating and fire hazards, the device must not be covered!

Behaviour in the event of an emergency

1. Switch off the device.
2. In an emergency, disconnect the device from the mains feed-in: Hold onto the mains plug while pulling the power cable out of the mains socket.
3. Do not reconnect a defective device to the mains.

Overheating protection

The device is provided with a safety thermostat which is activated by overheating of the device (when exceeding the operating temperature).

Once the safety thermostat has switched itself on, the device will be turned off.

When the device has cooled down sufficiently, the heating will be switched back on.

Investigate the cause of overheating.

If the safety thermostat does not switch in the event of overheating, the overheating protection will be tripped. In that case the device switches off completely. If so, please contact the customer service to have the overheating protection replaced.

Information about the device

Device description

The designer glass convector TCH 2010 E / TCH 2011 E is used to generate warm air for interior spaces.

The device generates heat by means of an electric heating element. The air surrounding the heating element is heated. The heated air rises through the air outlet and thus creates a natural suction that makes the cold room air flow into the device.

The device is equipped with an integrated temperature sensor which controls the heating depending on the current and the desired room temperature.

Using the touch panel integrated in the safety glass, you can set a target temperature value between 15 °C and 35 °C.

Moreover, the device is equipped with a remote control that can be used for controlling all functions and settings.

The feet's integrated castors allow for a convenient positioning of the device inside the room. The castors are fitted with a parking brake so as to prevent the device from rolling away inadvertently.

The functioning of the two devices is identical, they merely differ in appearance or to be precise in colour: The TCH 2010 E is white and the TCH 2011 E black.

Device depiction

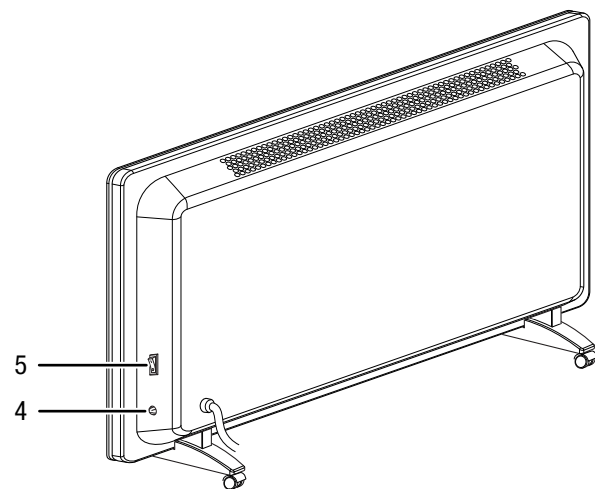
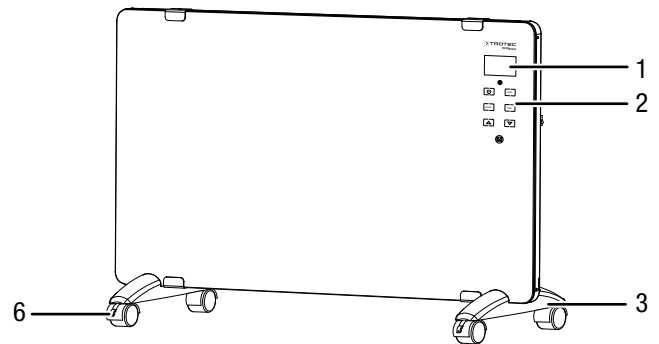

No.	Designation
1	Display
2	Control panel
3	Foot with castors
4	Temperature sensor
5	On/off switch
6	Parking brake for castors

Transport and storage

Note

If you store or transport the device improperly, the device may be damaged.

Note the information regarding transport and storage of the device.

Transport

To make the device easier to transport, it is fitted with wheels.

Before transporting the device, observe the following:

- Switch the device off.
- Release the brakes at the castors.
- Hold onto the mains plug while pulling the power cable out of the mains socket.
- Do not use the power cable to drag the device.
- Allow the device to cool down sufficiently.

Storage

Before storing the device, proceed as follows:

- Hold onto the mains plug while pulling the power cable out of the mains socket.
- Allow the device to cool down sufficiently.

When the device is not being used, observe the following storage conditions:

- dry and protected from frost and heat
- in an upright position where it is protected from dust and direct sunlight
- with a cover to protect it from invasive dust, if necessary
- Place no further devices or objects on top of the device to prevent it from being damaged.
- Remove batteries from the remote control.

Assembly and installation

Scope of delivery

- 1 x Device
- 1 x Remote control
- 2 x Foot
- 7 x Screw for feet
- 1 x Manual

Unpacking the device

1. Open the cardboard box and take the device out.
2. Completely remove the packaging.
3. Fully unwind the power cable. Make sure that the power cable is not damaged and that you do not damage it during unwinding.

Assembly

Assembly of feet with castors

1. Place the device on a table or on the packaging board with the glass surface pointing down.
2. Fasten both feet (3) with 3 screws each.

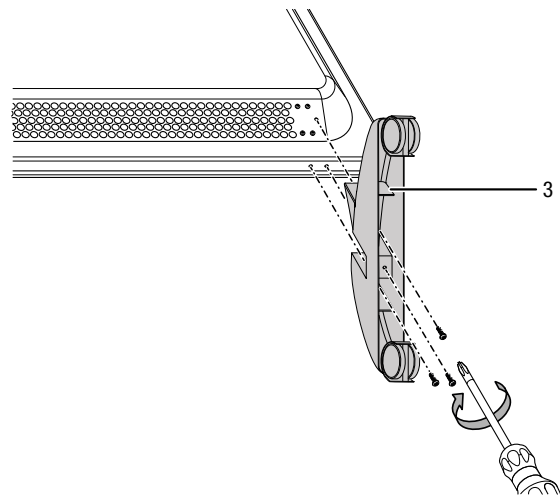

3. Check the feet (3) for tight fit.
4. Set the device up in an upright and stable position.
5. If required, engage the parking brakes (6) by pushing the lever down.

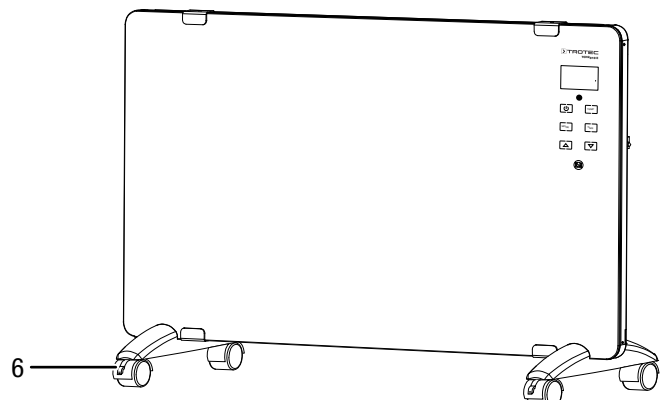

Start-up



Info

Odours might arise upon initial start-up or after a longer period of non-use.

When positioning the device, observe the minimum distance from walls or other objects as described in the Technical data chapter.

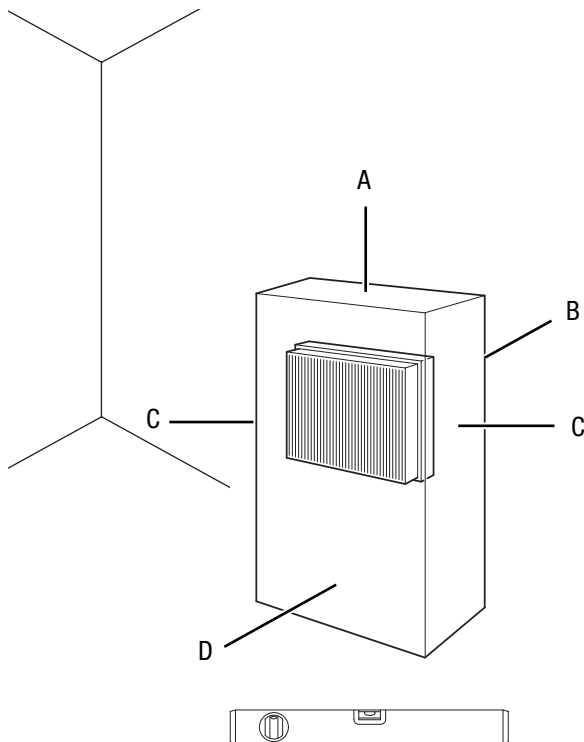

- Before restarting the device, check the condition of the power cable. If there are doubts as to the sound condition, contact the customer service.
- Set the device up in an upright and stable position.
- Do not create tripping hazards when laying the power cable or other electric cables, especially when positioning the device in the middle of the room. Use cable bridges.
- Make sure that extension cables are completely unrolled.
- Make sure that no curtains or other objects interfere with the air flow.
- Do not position the device directly below a wall socket.
- Make sure that the device cannot come into contact with moisture or water.

Prior to initial start-up, insert the batteries in the remote control.

Connecting the power cable

- Insert the mains plug into a properly secured mains socket.
- Make sure that the power cable is guided along the back of the device. Never guide the power cable along the front of the device!



Operation

- Avoid open doors and windows.

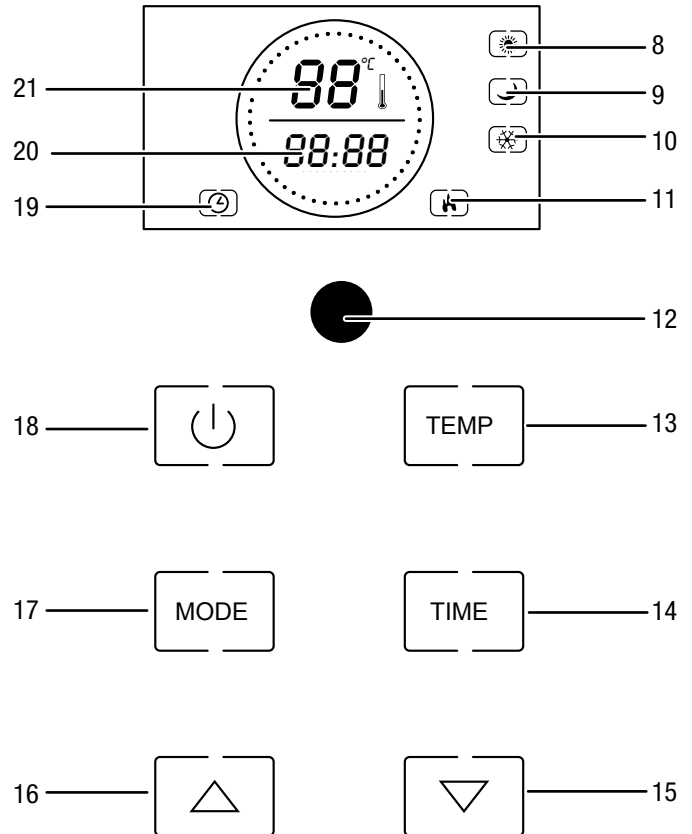
Control panel



No.	Designation	Meaning
8	<i>Comfort heating mode</i> indication	Is displayed with a black frame when <i>comfort heating mode</i> is activated.
9	<i>Economy heating mode</i> indication	Is displayed with a black frame when <i>economy heating mode</i> is activated.
10	<i>Frost monitor heating mode</i> indication	Is displayed with a black frame when <i>frost monitor heating mode</i> is activated.
11	<i>Heating</i> indication	Is displayed with a black frame when the heating is activated.
12	Infrared receiver	For signal reception from the remote control
13	TEMP button	For setting the desired room temperature
14	TIME button	For switching the timer function on and off (1 min to 24 h): 1 to 23 h in increments of 1 h, 1 to 59 min in increments of 1 min

No.	Designation	Meaning
15	<i>Decrease value</i> button	For setting the desired room temperature (15 °C to 35 °C) or the number of hours and minutes for the timer (1 min to 24 h)
16	<i>Increase value</i> button	
17	<i>MODE</i> button	For selecting the operating mode:  = <i>Comfort heating mode</i>  = <i>Economy heating mode</i>  = <i>Frost monitor heating mode</i>
18	<i>Power</i> button	For switching the device on or activating standby mode
19	<i>Timer</i> indication	Flashes when the timer is activated.
20	<i>Hours / minutes</i> indication	Indication of the number of hours and minutes during timer programming Indication of remaining timer run-time
21	<i>Temperature</i> indication	Indication of the current room temperature during operation Indication of the desired room temperature during temperature adjustment



Info

The display comes with a blue background illumination. The background illumination switches on as soon as one of the control panel buttons is pressed. After approx. 30 s without any input, the background illumination switches back off.

Switching the device on

Once you have completely installed the device as described in the Start-up chapter, you can switch it on.

- Set the on/off switch (5) to I.
 - ⇒ An acoustic signal is emitted.
 - ⇒ The device is now in standby mode.
- Press the *power* button (18).
 - ⇒ The device starts in *frost monitor heating mode*.
 - ⇒ The *frost monitor heating mode* indication (10) is displayed with a flashing black frame.



Info

In standby mode, the device memorizes the room temperature setting.

Setting the operating mode

Mode

The following types of heating can be selected:

- *Comfort heating mode* (heating capacity 2000 W)
- *Economy heating mode* (heating capacity 1000 W)
- *Frost monitor heating mode*

- Press the *MODE* button (17) until the desired heating mode is selected.
 - ⇒ The selected mode and the *heating* indication (11) will be displayed edged in black.

Comfort heating mode

The device operates with a heating capacity of 2000 W until reaching the desired room temperature. Upon reaching the desired room temperature the device reduces its heating capacity to 1000 W. The *comfort heating mode* indication (8) continues to be displayed.

If the determined room temperature exceeds the desired room temperature by 2 °C, the heating switches off.

The *heating* indication (11) is no longer framed.

If the determined room temperature falls below the desired room temperature by 2 °C, the heating switches back to *comfort heating mode*.

Economy heating mode

The device operates with a heating capacity of 1000 W until the determined room temperature reaches the desired room temperature. Then the heating switches off.

The *heating* indication (11) is no longer framed.

If the determined room temperature falls below the desired room temperature by 2 °C, the heating switches back to *economy heating mode*.

Frost monitor heating mode

In *frost monitor heating mode* the device heats automatically if the room temperature is below 5 °C. This temperature cannot be changed.

Setting the desired room temperature

The room temperature determined by the temperature sensor (5) is displayed on the *temperature* indication (21). You can set the desired room temperature at any time.

The room temperature is preset to 35 °C.

- Press the *TEMP* button (13).
 - ⇒ The *temperature* indication (21) flashes.
 - ⇒ The desired room temperature is displayed.
- Press the arrow buttons *increase value* (16) or *decrease value* (15) to adjust the desired room temperature. Setting is possible in the range between 15 °C and 35 °C in increments of 1 °C.
 - ⇒ The desired room temperature is saved and shown on the *temperature* indication (21) for approx. 5 seconds. Then the current room temperature is displayed again.



Info

The desired room temperature should be higher than the current room temperature.

Setting the timer

The timer has the following functionality:

- automatic switch-off upon expiry of a preset number of hours.

The timer run-time can be between 1 minute and 24 hours and can be adjusted in increments of 1 min.

Note

Do not leave the operating device unattended in a freely accessible room with an activated timer.

Automatic switch-off

- ✓ The device is switched on.
1. Press the *TIME* button (14).
 2. Select the desired number of hours by use of the arrow buttons (15 or 16). The value range is between 1 and 23.
 - ⇒ The number of hours flashes on the *hours / minutes* indication (19).
 3. Press the *TIME* button (14).
 4. Select the desired number of minutes by use of the arrow buttons (15 or 16). The value range is between 1 and 59.
 - ⇒ The number of minutes flashes on the *hours / minutes* indication (20).
 5. Press the *TIME* button (14).
 - ⇒ The desired time until automatic switch-off is saved.
 - ⇒ The *timer* indication (19) flashes.
 - ⇒ The time left until switch-off is shown on the *hours / minutes* indication (20) and counted down.
 - ⇒ In device will then switch to standby mode.

Notes regarding automatic switch-off:

- Manually switching the device off disables the automatic switch-off function.
- If you select 0 hours / minutes, the timer will be off.

Remote control

All settings of the device can also be made using the remote control included in the scope of delivery.

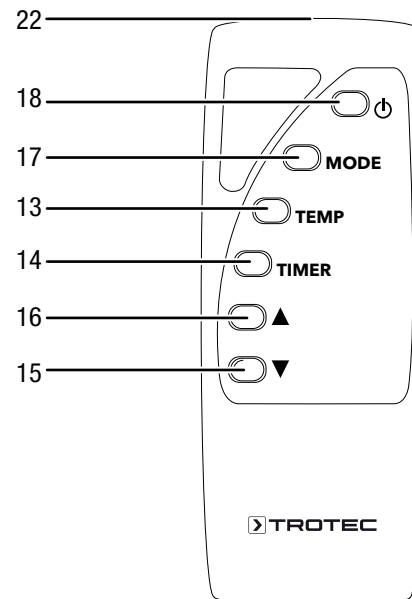

No.	Designation	Meaning
13	<i>TEMP</i> button	Setting the desired room temperature
14	<i>TIME</i> button	Switching the timer function on and off (1 min to 24 h): 1 to 23 h in increments of 1 h, 1 to 59 min in increments of 1 min
15	<i>Decrease value</i> button	Setting the desired room temperature (15 °C to 35 °C) or the number of hours and minutes for the timer (1 min to 24 h)
16	<i>Increase value</i> button	hours and minutes for the timer (1 min to 24 h)
17	<i>MODE</i> button	For selecting the operating mode: <i>Comfort heating mode</i> <i>Economy heating mode</i> <i>Frost monitor heating mode</i>
18	<i>Power</i> button	Switching the device on or activating standby mode
22	Transmitter	Sends signals to the device.

Shutdown



Warning of electrical voltage

Do not touch the mains plug with wet or damp hands.

1. Switch the device off.
2. Hold onto the mains plug while pulling the power cable out of the mains socket.
3. Allow the device to cool down sufficiently.
4. Clean the device according to the Maintenance chapter.
5. Store the device according to the Storage chapter.

Errors and faults



Warning of electrical voltage

Tasks which require the housing to be opened must only be carried out by authorised specialist companies or by Trotec.

The device has been checked for proper functioning several times during production. If malfunctions occur nonetheless, check the device according to the following list.

The device does not start:

- Check the power connection.
- Check the power cable and mains plug for damages.
- Check the on-site fusing.
- Wait for 10 minutes before restarting the device. If the device is not starting, have the electrics checked by a specialist company or by Trotec.

The device is switched on, but the heating is not operating:

- Check the room temperature. The room thermostat may have switched off, because the desired room temperature has been reached.
- Check whether the overheating protection has tripped, see chapter Safety.
- The heating resistor might have blown. Have a defective heating resistor replaced by a specialist electrical company.
- The room thermostat might be defective. Have a defective room thermostat replaced by a specialist electrical company.

The air current is reduced:

- Check the air inlet and outlet. Make sure that air inlet and outlet are not obstructed. Remove any dirt. Observe the minimum distance from walls or other objects according to the technical data.

The device does not respond to the infrared remote control:

- Check whether the distance between remote control and device is too large and reduce it if necessary.
- Make sure there are no obstacles, such as furniture or walls, between the device and the remote control. Ensure visual contact between device and remote control.
- Check the charging status of the batteries and change them if required.
- If the batteries have only just been changed, check them for correct polarity.

Note

Wait for at least 3 minutes after maintenance and repair work. Only then switch the device back on.

Your device still does not operate correctly after these checks?

Please contact the customer service. If necessary, bring the device to an authorized specialist electrical company or to Trotec for repair.

Maintenance

Activities required before starting maintenance



Warning of electrical voltage

Do not touch the mains plug with wet or damp hands.

- Switch the device off.
- Hold onto the mains plug while pulling the power cable out of the mains socket.
- Allow the device to cool down completely.



Warning of electrical voltage

Tasks which require the housing to be opened must only be carried out by authorised specialist companies or by Trotec.

Cleaning the housing



Warning of electrical voltage

Never immerse the device in water!

Clean the housing with a soft, damp and lint-free cloth. Ensure that no moisture enters the housing. Protect electrical components from moisture. Do not use any aggressive cleaning agents such as cleaning sprays, solvents, alcohol-based or abrasive cleaners to dampen the cloth.

Wipe the housing dry after cleaning.

Technical annex

Technical data

Parameter	Value	
Model	TCH 2010 E	TCH 2011 E
Housing colour	white	black
Heating capacity	1000–2000 W	1000–2000 W
Setting range	15 °C to 35 °C	15 °C to 35 °C
Mains connection	220–240 V / 50–60 Hz	220–240 V / 50–60 Hz
Power consumption	2000 W	2000 W
Nominal current consumption	8.7 A	8.7 A
Cable length	1.5 m	1.5 m
Plug type	CEE 7/7	CEE 7/7
Dimensions (depth x width x height)	80 x 840 x 470 mm	80 x 840 x 470 mm
Minimum distance to walls and other objects	A: top: 100 cm B: rear: 50 cm C: side: 50 cm D: front: 50 cm	100 cm 50 cm 50 cm 50 cm
Weight	8 kg	8 kg

Information requirements for electrical local space heaters

Parameter	Value / item	
	TCH 2010E	TCH 2011E
Model	TCH 2010E	TCH 2011E
Heat output		
Nominal heat output P_{nom}	2 kW	2 kW
Minimum heat output (indicative) P_{min}	1 kW	1 kW
Maximum continuous heat output $P_{max,c}$	2 kW	2 kW
Auxiliary electricity consumption		
At nominal heat output $e_{l,max}$	NA	NA
At minimum heat output $e_{l,min}$	NA	NA
In standby mode $e_{l,sb}$	0.00096 kW	0.00096 kW
Type of heat input		
Manual heat charge control, with integrated thermostat	NA	NA
Manual heat charge control with room and/or outdoor temperature feedback	NA	NA
Electronic heat charge control with room and/or outdoor temperature feedback	NA	NA
Fan assisted heat output	NA	NA
Type of heat output/room temperature control		
Single stage heat output, no room temperature control	NO	NO
Two or more manual stages, no room temperature control	NO	NO
With mechanic thermostat room temperature control	NO	NO
With electronic room temperature control	NO	NO
With electronic room temperature control plus day timer	YES	YES
With electronic room temperature control plus week timer	NO	NO
Other control options		
Room temperature control, with presence detection	NO	NO
Room temperature control, with open window detection	NO	NO
With distance control option	YES	YES
With adaptive start control	NO	NO
With working time limitation	YES	YES
With black bulb sensor	NO	NO
Contact details	Trotec GmbH Grebbener Straße 7 D-52525 Heinsberg	

NA: not applicable

Disposal



The icon with the crossed-out waste bin on waste electrical or electronic equipment stipulates that this equipment must not be disposed of with the household waste at the end of its life. You will find collection points for free return of waste electrical and electronic equipment in your vicinity. The addresses can be obtained from your municipality or local administration. For further return options provided by us please refer to our website www.trotec24.com.

The separate collection of waste electrical and electronic equipment aims to enable the re-use, recycling and other forms of recovery of waste equipment as well as to prevent negative effects for the environment and human health caused by the disposal of hazardous substances potentially contained in the equipment.

In the European Union, batteries and accumulators must not be treated as domestic waste, but must be disposed of professionally in accordance with Directive 2006/66/EC of the European Parliament and of the Council of 6 September 2006 on batteries and accumulators. Please dispose of batteries and accumulators according to the relevant legal requirements.

Trotec GmbH

Grebener Str. 7
D-52525 Heinsberg

☎ +49 2452 962-400

☎ +49 2452 962-200

✉ info@trotec.com

www.trotec.com